



**BF25 | STICK BUILT CURTAIN WALL SYSTEM**

**TECHNICAL DATA**

With its wide range scope of design applications BF25 curtain wall system offers following feature:





**STANDARD FEATURES**

- 2.5" frame width
- 2" to 7" frame depth
- 3/32" wall thickness
- Thermally broken aluminum profiles
- Air, water and dust sealing gaskets made of EPDM
- Powder coating with all standard RAL colors and various anodized colors
- Qualicoat & Qualanod certified surface treatment applications.
- 1" Insulated glass unit.
- Concealed vents with multi-point locking for openings
- Stainless steel and aluminum projected hardware
- Aluminum handle

- Hardware options to limit vent access to custodial use

**OPTIONAL FEATURES**

- Powder coated dual finish (two-tone color) option
- High insulated profile system for better energy efficiency
- Up to 2" Insulated glass with low-e or solar low-e options
- Warmedge spacer and triple IGU to maximize energy efficiency
- Sound insulated profile system for superior OITC ratings
- Silicone gaskets
- Bird friendly glazing
- Integration of BF64 or BF74 system's all types of openings
- Motorized concealed opening options
- Caps with various shapes and depth

	Residential Building
	Commercial Building
	Hotel
	School
	Hospital

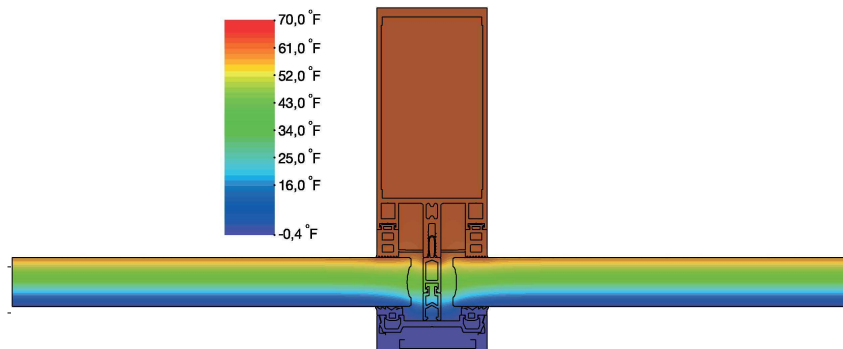
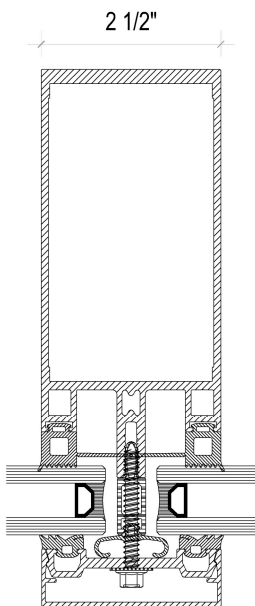

**PERFORMANCE VALUES**

Air infiltration	<0.01cfm/ft <sup>2</sup> @ 6.24 psf
Water penetration (Static)	15 psf
Water penetration (Dynamic)	15 psf
U-Value	0.28 - 0.48 Btu/(h.ft <sup>2</sup> .°F)